

User Manual

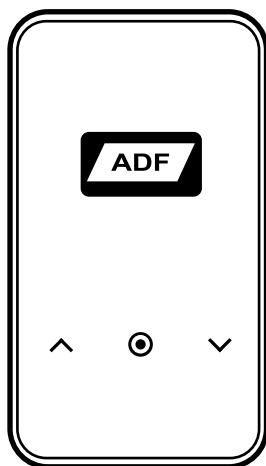

T1 Smart Thermostat v1.0



Table of contents

Table of contents	2 - 3
Product description	4
T1 General feature	5
- Remote control	
- Schedule	
- Alarm	
- Historical data logging	
- Geolocation	
- AI control	
Device interface overview	6
Initial Setup	6
- What's in the box	
- Power up	7
- User registration (on mobile apps)	8 - 9
- Setup T1 connect to Internet (with mobile apps)	10 - 14
Share Function	15 - 16
Device Placement	17
OLED HMI interface	18 - 21
- Display and button interface	18
- Main Menu Interface:	18 - 19
- View Alarm	20
- Alarm Setting	20 - 21
Mobile apps interface	22
- Control air-conditioner	
- View Trends	23
- Schedule	24 - 25
- Smart Control Setting	26 - 27
- AC Brand Selection (Auto)Setting	28 - 33
- AC Brand Selection (Manual)	34 - 38
- Geolocation Functionality	39 - 42

Frequently asked question	43 - 44
Device not able to power up troubleshooting	43
System not working troubleshooting	43
- Cloud setting not working	
Shifting T1 to another AC Unit within same house/office.	43
Shifting T1 to another AC Unit for different house/office.	43
When AC Unit and Mobile App On/Off Status not the same.	43
Setup process failed troubleshooting	43
- AC Setup Process failed	
- Supported AC Brands	
- Wifi setup process failed	44
Technical support	44
- Technical support channel	

Product Description



T1

T1 Smart Thermostat

T1 Smart Thermostat is a smart air-conditioner controller that provides best comfort and convenience to end users. T1 smart thermostat uses built-in, external sensors and air-conditioner(AC) unit control information to model environment information and AC unit performance. Based on essential data collected, T1 smart thermostat leverages on AI technology to process data and control AC unit. The intelligent AC unit control provides the best comfort level and convenience while maximizing electricity efficiency.

T1 General feature

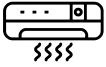

Remote control

- T1 support most of the existing air-conditioning unit in the market. It only required to follow an easy setup procedure to enable the control on air-conditioner.
- T1 is internet-connected device that allow user access everywhere as long as there is internet connectivity.



Schedule

- T1 allows users to schedule future events to maximize convenience and comfort.



Alarm

- T1 monitors temperature and humidity and alert user upon abnormality and change in temperature.



Historical data logging

- T1 logs historical temperature and humidity data for user reference.
- T1 logs historical air-conditioner control and status event for user reference.



Geolocation

- T1 track user location and automatically turn on and off whenever user leave and return home.



AI control

- T1 able to learn and model on air-conditioner behaviour and automatically control it to provide the best comfort and convenience to the user.

Device interface overview

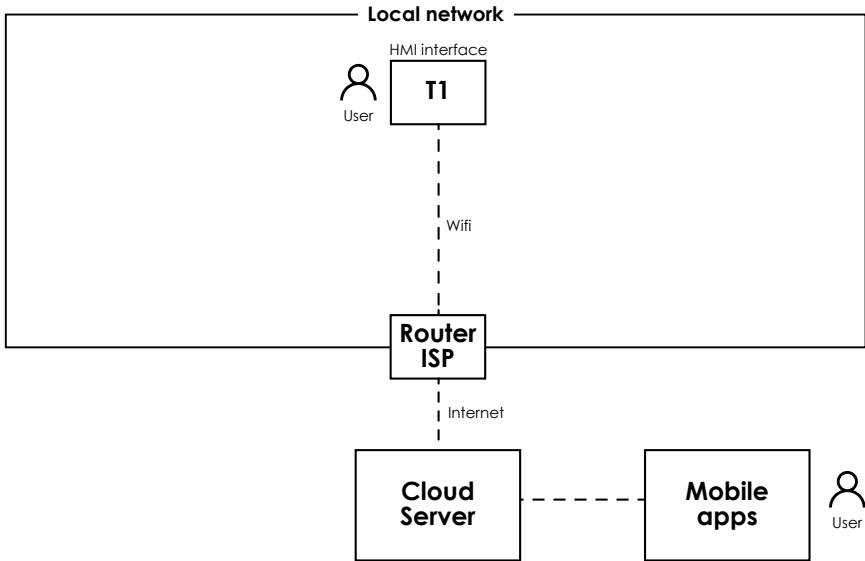

Initial Setup

What's in the box

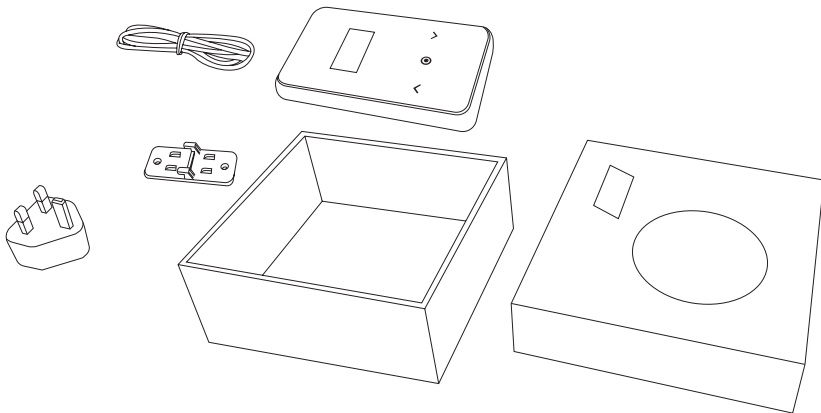

Power up

1. Power up T1

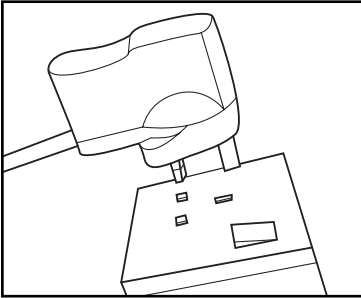

a. Plug in USB power brick to any 100v - 240v power point.

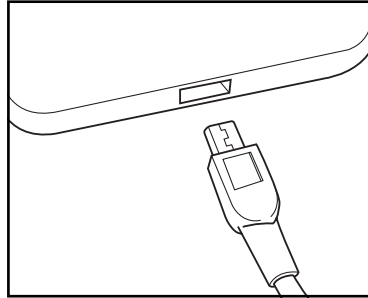

b. connect the USB cable to T1.



c. "ADF" logo should appear on T1's display.

2. Wait for about 1 minute until the device successfully boots.

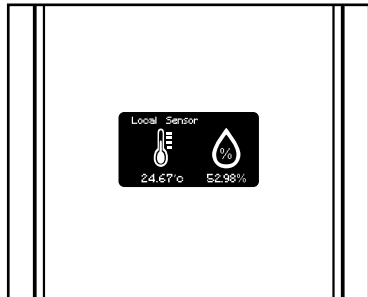
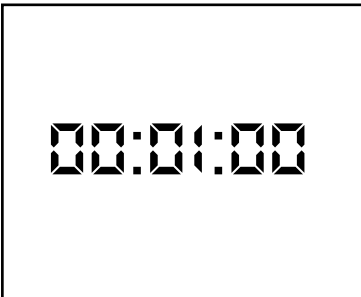

User Registration (on mobile apps)

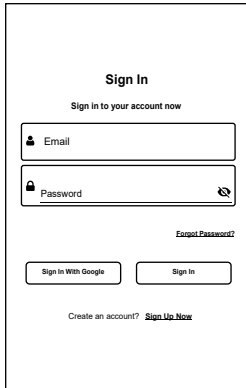

1. Launch T1 Smart Thermostat apps



2. Press the "sign up" button

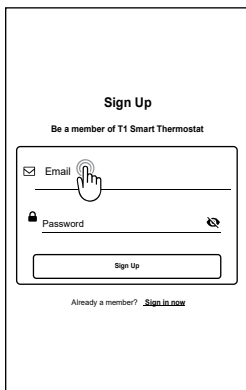

3. Sign up a new account, user can either
- a. Enter details (**email, name, password, phone number**)
 - b. Click the red google button to sign up using google account

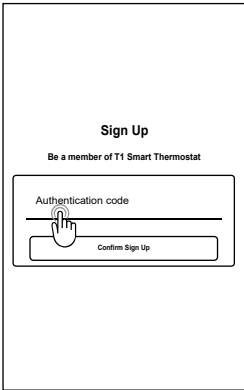

4. Upon completion, an authentication code will be sent to the email address entered.

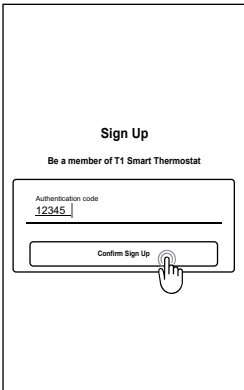

5. User will need to key in the code to complete sign up process.

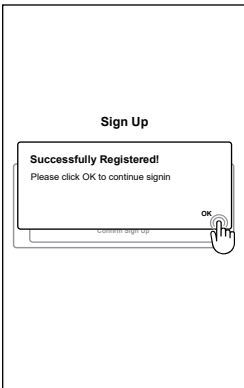

6. Upon registration, user can use this account to login T1 Smart Thermostat mobile apps.

Setup T1 connect to Internet (with mobile apps)

Prerequisite:

1. T1 smart thermostat app must already be installed in Smartphone.
2. User registration process must be done prior. (See page 8)

Step:

1. Power up T1, T1 device should be in "hotspot" mode upon on factory default setting.

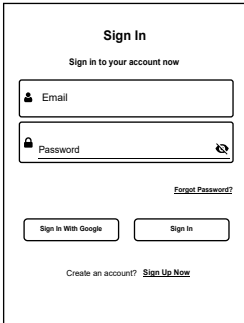

1. Sign in into Smart thermostat device.

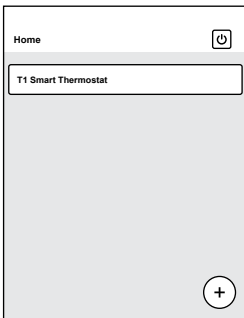

2. Go to home page and select the green "+" button at the right bottom.

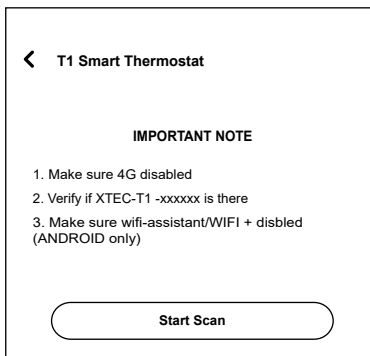

3. A pop up window would appear to check the following:
 - a) phone 4G is disabled
 - b) XTEC-T1-XXXXXX wifi is available to connect.
 - c) wifi-assistant/WIFI + disbled(ANDROID only).
 - d) click start scan after confirmed above condition.

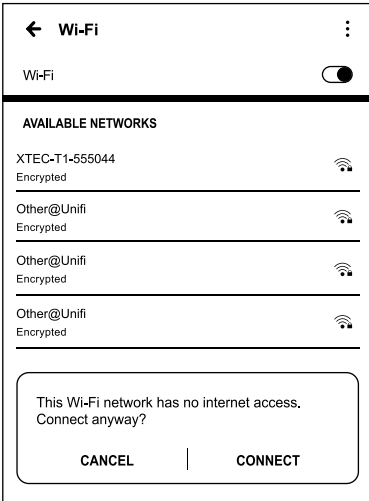

4. Connect to T1 Wi-Fi hotspot (XTEC-T1-XXXXXX)
 - a) Using the default password "12345678".

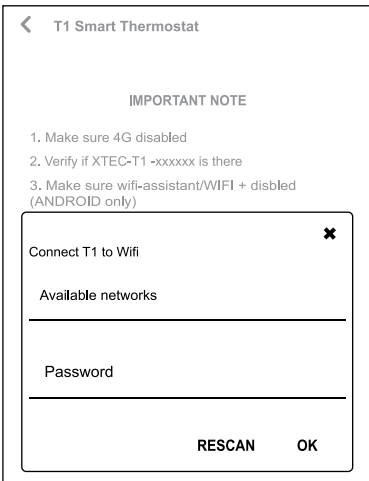

5. Return to the T1 smart thermostat app. The following page will pop up.

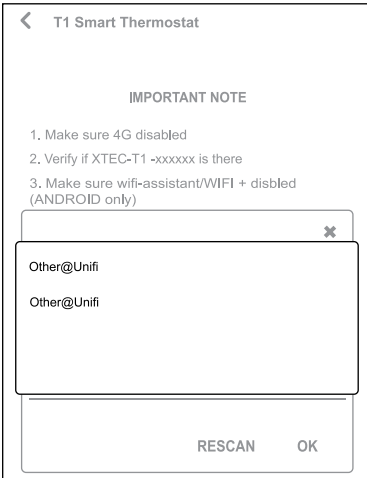

6. Select your home/office Wi-Fi network and input the SSID password to allow T1 to connect into it.

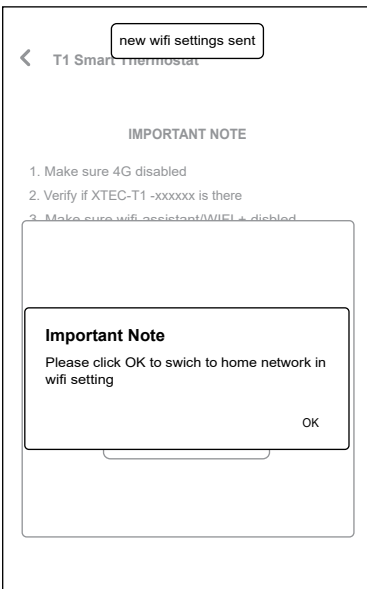

7. When connection is complete...

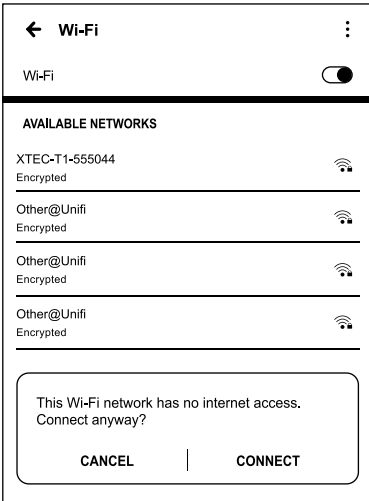

8. Select back your home/office Wi-Fi network and input the SSID password to connect your phone back to your WIFI.

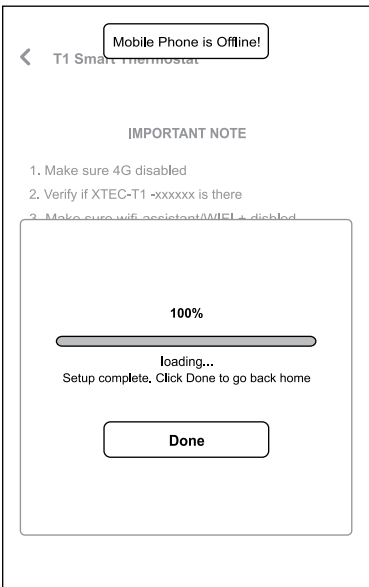

9. user is now successfully connected with T1 smart thermostat.

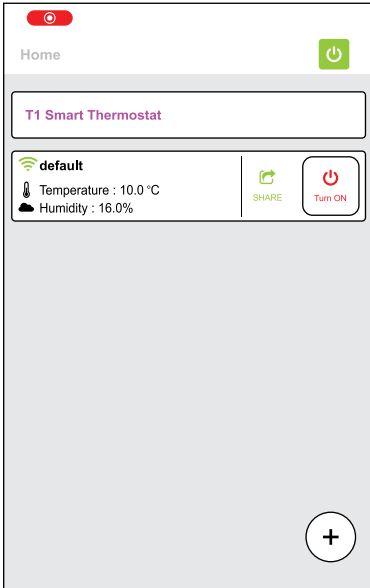

10. Check for the confirmation:
 - i. Make sure your device is online (green color symbol)
 - ii. Otherwise, if the device is offline, please reboot T1 device or restart your app.

Share Function

Prerequisite:

1. User must already be registered with a T1 Smart Thermostat account.
2. The device is already connected to internet.

Step:

1. Launch T1 Smart Thermostat app.

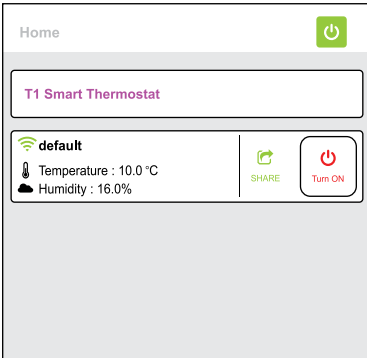

1. Click on the SHARE button

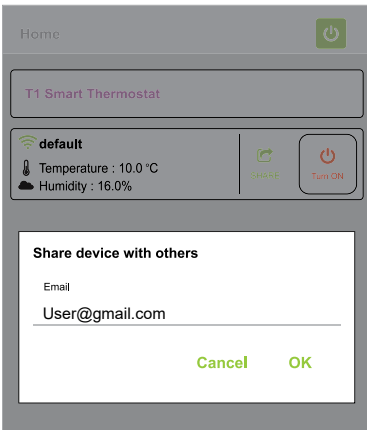

2. Key in the email address that you would like to share with.
*Make sure the other user already registered their email.

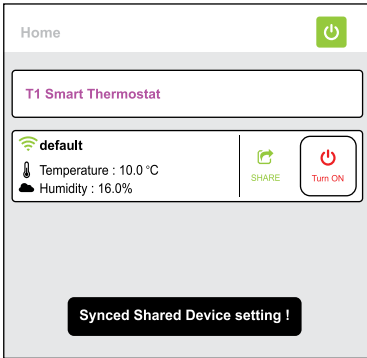

3. Once keyed in the email and click OK, the app will display "Synced Shared Device Setting!"

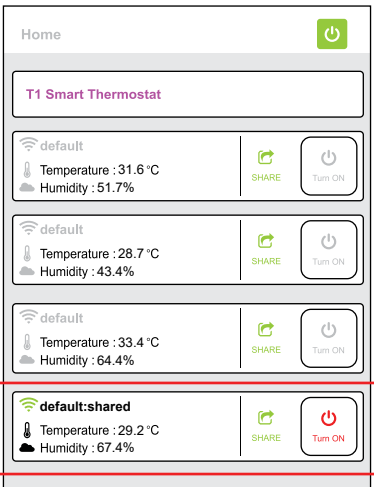

4. It will automatically display "shared" in the user's application.

Device Placement

1. T1 smart thermostat should be pointed directly into the AC split unit so that it could control the AC unit.

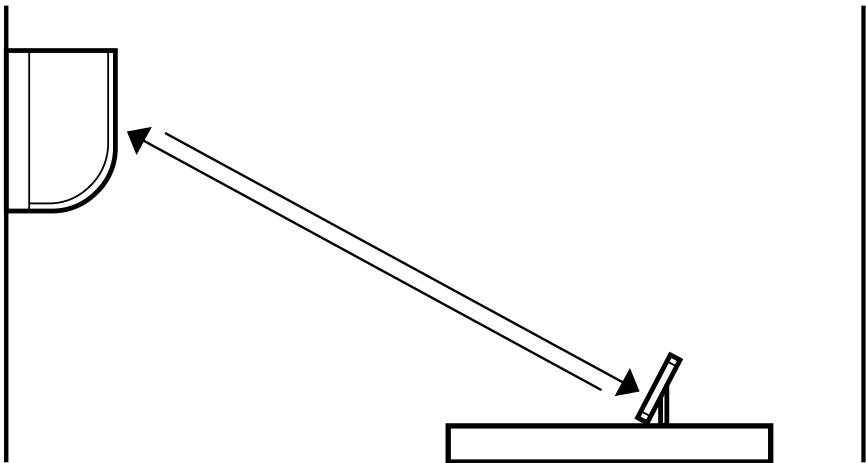
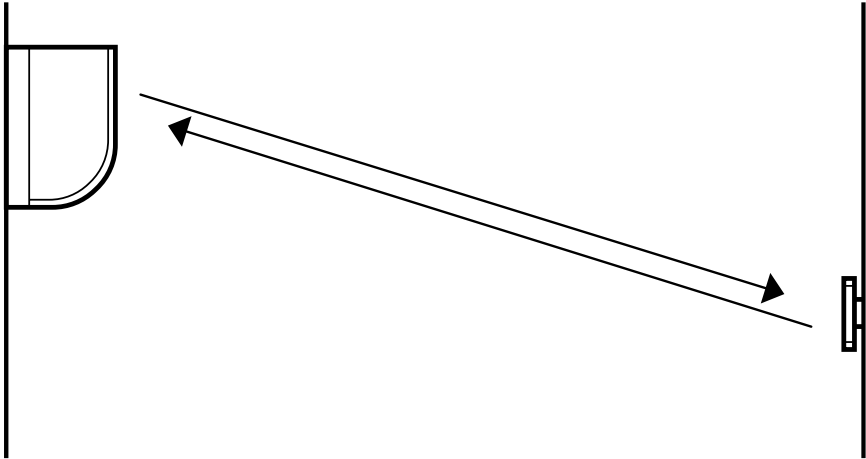

OLED HMI Interface

Display and button interface

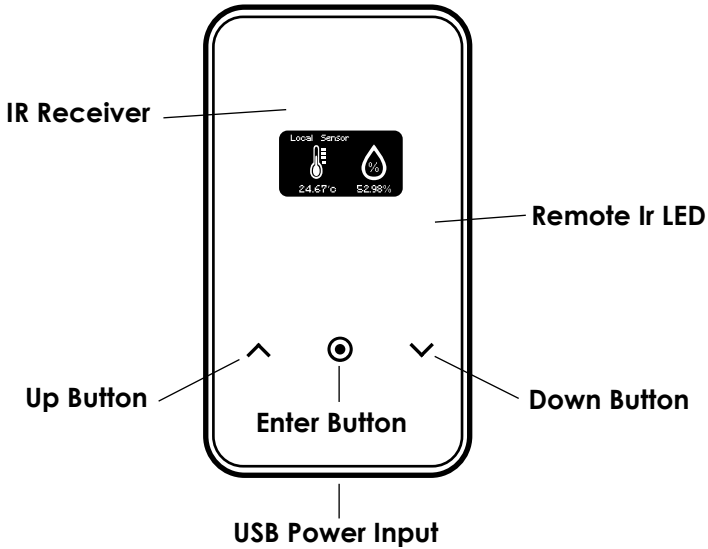

Main Menu Interface:

1. Press "up" and "down" to run through menu as below:
2. Press "enter" to enter load into menu and update changes (except "Local Device Info")
3. For local sensor menu, refer to "Quick Setpoint Menu" below for control.
4. Upon entering into menu, select "OK" to confirm or "cancel" to exit menu.



Powering up screen

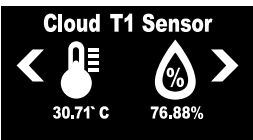

Temperature & Humidity Sensor Screen



AC Setpoint Screen

- Press enter to change AC Setpoint



AC ON/OFF Screen

- Press enter to turn ON/OFF AC



AC Sync ON/OFF Screen

- Press enter to sync ON/OFF AC



AC Mode screen

- Press enter to change AC mode setting



AC Fan speed screen

- Press enter to change AC Fan speed



AC Swing screen

- Press enter to change AC swing status



AC Swing screen

- AP Mode means connected to WIFI router
- HotSpot Mode means
 - o Ready to be added
 - o Does not able to detect WIFI router
- Internet status
 - o OK - Connected to internet
 - o NG - Failed in connect to internet



Device Version screen

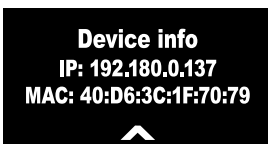

Device Info screen

- Device IP and MAC address information



Factory default screen

- Happened when user pressed factory default button for 5 seconds
- Press Enter and select YES to perform factory default.

View Alarm

Alarm Trends		☰
Date : 2019-10-02	Time : 09:15:30	
Type : Performance Drop		
Date : 2019-10-03	Time : 09:15:30	
Type : Sensor fault		
Date : 2019-10-04	Time : 09:15:30	
Type : Sensor fault		
Date : 2019-10-05	Time : 09:15:30	
Type : Alarm		
Date : 2019-10-11	Time : 09:15:30	
Type : Performance Drop		
Date : 2019-10-12	Time : 09:15:30	
Type : Sensor fault		
Date : 2019-10-13	Time : 09:15:30	
Type : Sensor fault		
Date : 2019-10-14	Time : 09:15:30	
Type : Alarm		
Date : 2019-10-14	Time : 09:15:30	
Type : Performance Drop		

1. In alarm view page, there would be alarm log for viewing.
2. User can select different device to view alarm log.

Alarm Setting

Alarm Settings		☰
Choose Device		
Device 1		
Temperature Deadband	=	<input type="text" value="55"/> °C
Min. Temp	=	<input type="text" value="98"/> °C
Max. Temp	=	<input type="text" value="98"/> °C
Humidity Deadband	=	<input type="text" value="98"/> %
Min.Humidity	=	<input type="text" value="22"/> %
Max.Humidity	=	<input type="text" value="32"/> %
<input type="button" value="SAVE"/>		

1. In alarm setting, users can use T1 to monitor temperature and humidity and alert users during change of temperature.
2. In the settings, users can set the maximum and minimum threshold for the temperature and humidity, with deadband value.
3. If the temperature/Humidity exceeds the threshold value, an alarm will be triggered, and the user would receive a notification.

- **Example working graph**

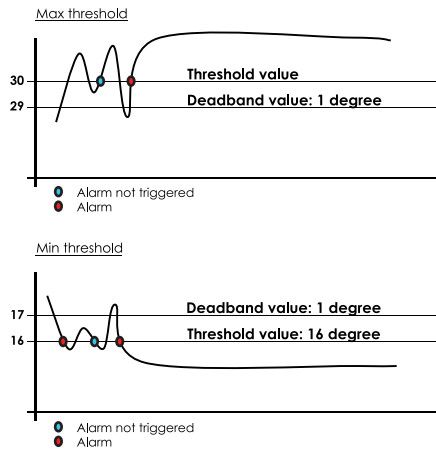

- **Alarm working principle:**

- If values happen to go higher/lower than the max/min value, the alarm will be triggered.
- When triggered, the value must go higher/lower than the dead band value to retrigger the alarm again.

Mobile Apps Interface

Home

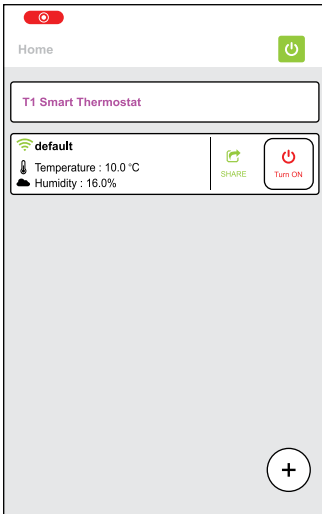

1. Display of T1 thermostat conditions.
2. Display of current AC control information.

Control air-conditioner

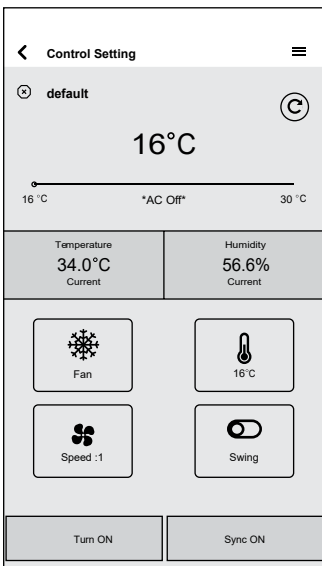

1. Display of T1 thermostat conditions.
2. From the settings, user can update any settings from the interface and click "change" button to update changes in settings.
3. When AC status is off, settings are disabled from making changes. If the current AC status is out of sync with current AC status, user is required to press "**Syn_OFF**" or "**Syn_ON**" to sync back the AC status.

View Trends

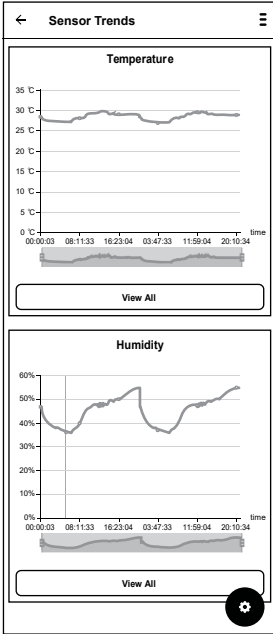

1. In the trend page, there would be a sensor trends graph and AC log graph.
2. User can view the sensor & AC log.

Schedule

← Schedule View				☰
23:00:00	Dev_id: 14	Fan :M	ode : 1 REPEAT	<input type="checkbox"/>
00:00:00	Dev_id: 11	Fan :M	ode : 1 REPEAT	<input type="checkbox"/>
00:00:00	Dev_id: 11	Fan :M	ode : 1 REPEAT	<input type="checkbox"/>
00:00:00	Dev_id: 11	Fan :M	ode : 1 REPEAT	<input type="checkbox"/>
00:00:00	Dev_id: 11	Fan :M	ode : 1 REPEAT	<input type="checkbox"/>
00:00:00	Dev_id: 11	Fan :M	ode : 1 REPEAT	<input type="checkbox"/>
00:00:00	Dev_id: 11	Fan :M	ode : 1 REPEAT	<input type="checkbox"/>
00:00:00	Dev_id: 11	Fan :M	ode : 1 REPEAT	<input type="checkbox"/>
00:00:00	Dev_id: 11	Fan :M	ode : 1 REPEAT	<input type="checkbox"/>
00:00:00	Dev_id: 11	Fan :M	ode : 1 REPEAT	<input type="checkbox"/>

1. In the Schedule page, user can view the list of schedule setting within the device.
2. Maximum schedules can be set is 10.
3. User will be able to set the schedule to be on or off from this view.
4. Upon pressing specific setting, user will be able to view the detailed setting.

Select Schedule Option

Custom ^

Sunday

Monday

Tuesday

Wednesday

Thursday

Friday

Saturday

Weekdays (Monday-Friday)

Weekend

Everyday

CANCEL
SUBMIT





5. While in schedule detail, user can either set specific dates or days within a week (Monday, Tuesday, Wednesday... etc) for the schedule to trigger.

< Update Schedule Settings

Schedule ID : 3 Schedule State

Select date

Select time

 Cooling	 Speed : 1	 25 °C	 Swing
--	--	--	--

Set Schedule : Custom

AC : ON

Notify Status: enabled

6. User can set the time for the schedule to trigger.
7. User can set the AC control setting for scheduled event.
8. User can select either to be notified on push notification whenever the event happens.

Smart Control Setting

1. To check whether your smart control setting is enabled, go to smart control page.

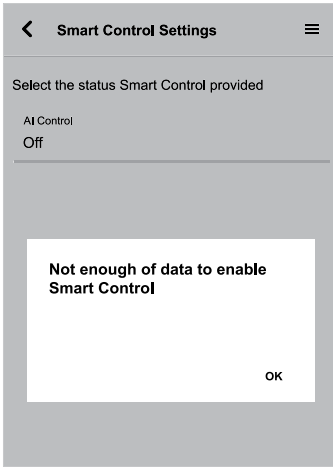

Not Allow

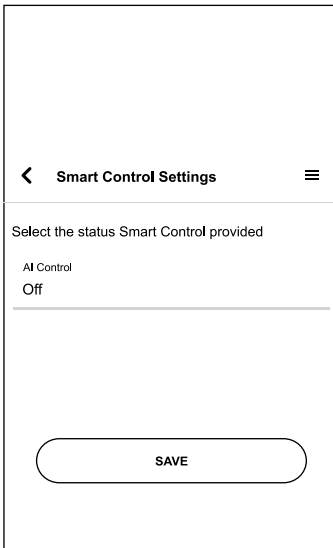

Allow

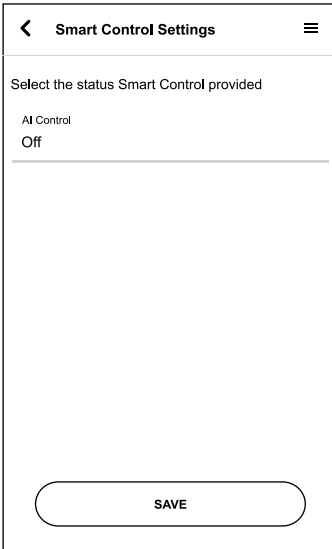

2. When allowed, Smart Control is enabled.

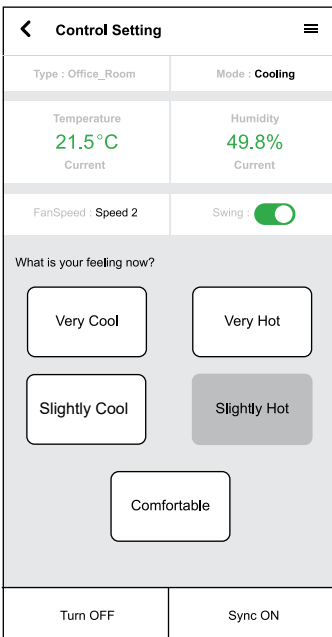

3. Upon Enabling, the control page will be like the following.
* User can click on 5 responses (Very cool, very hot, Slightly cool, slightly hot, comfortable) to indicate current feeling using the AC.

AC Brand Selection (Auto) Setting

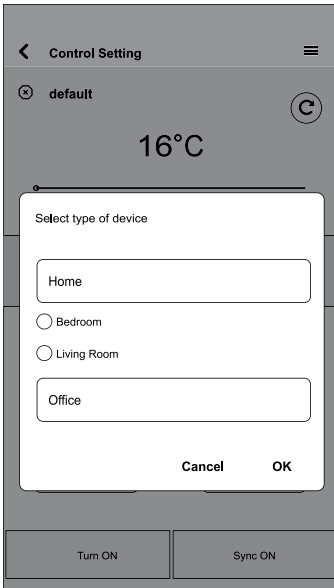

1. Select the device, then choose option for either home/office.

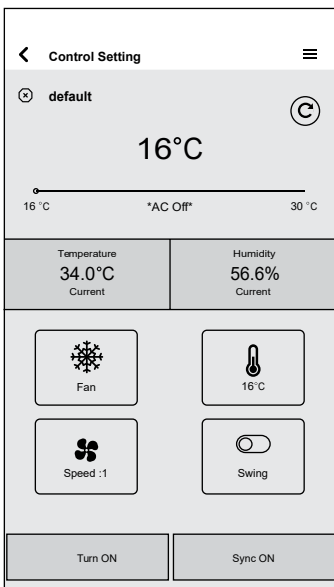

2. Click the 3 line at the top right corner.

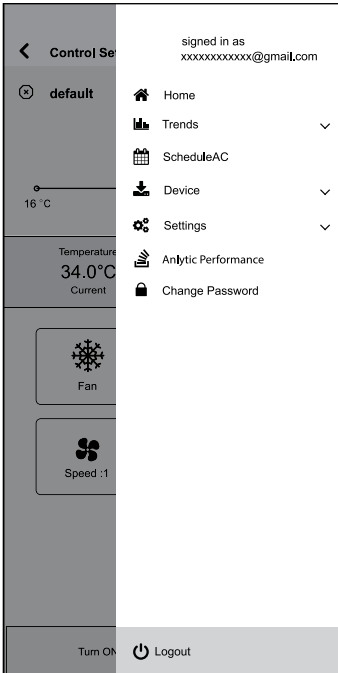

3. select "Settings"

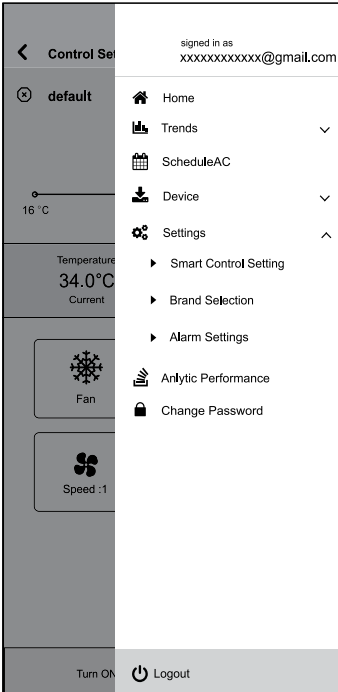

4. choose Brand Selection

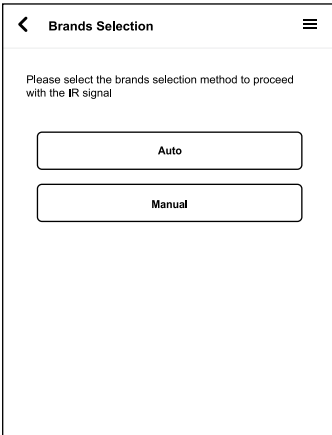

5. Select method to proceed with the IR signal pairing by choosing Auto.

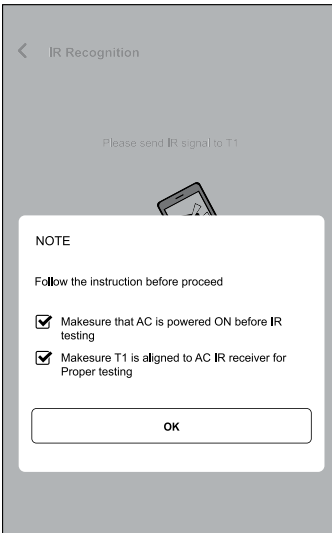

6. Follow the instruction before proceeding.

- i. Make sure that AC is powered On before IR testing
- ii. Make sure T1 is aligned to AC IR receiver for proper testing.

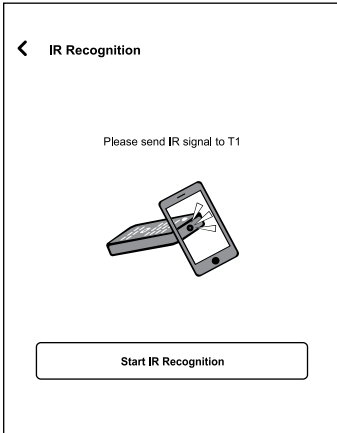

7. Start IR Recognition

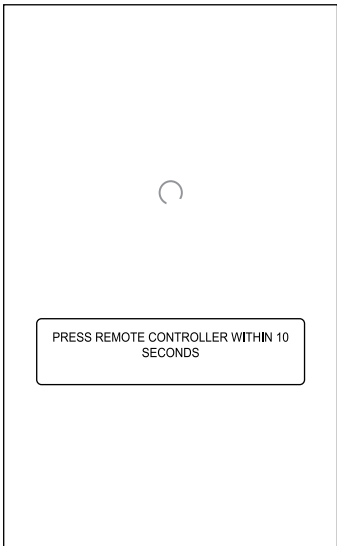

8. Device will automatically detect the brand of your AC, then select it to pair with it.

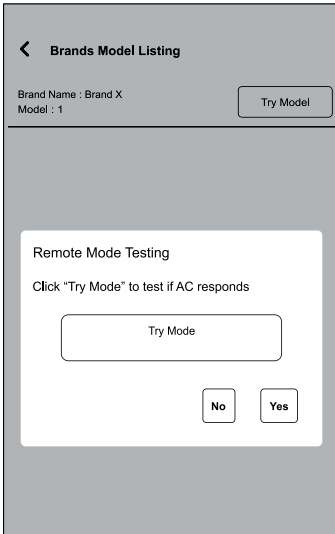

9. Click Try Model for remote recognition. If AC respond, you must click Yes, If no response, click No.

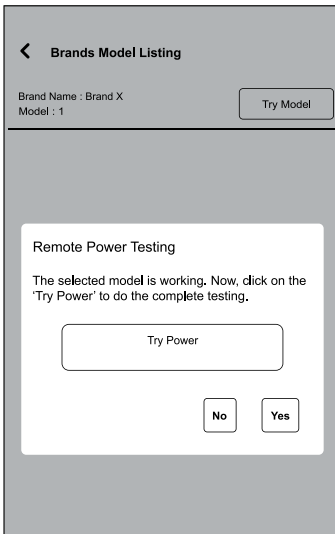

10. The selected model is working. Now, click on the "Try Power" to do the final testing.

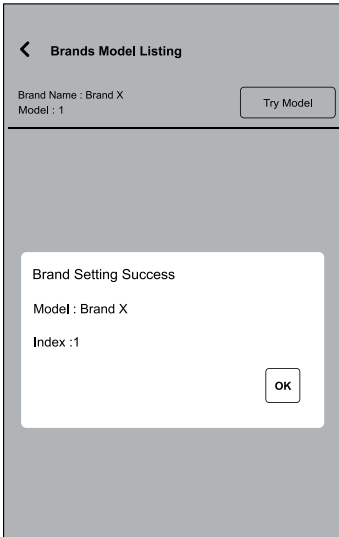

11. Upon completion, click OK

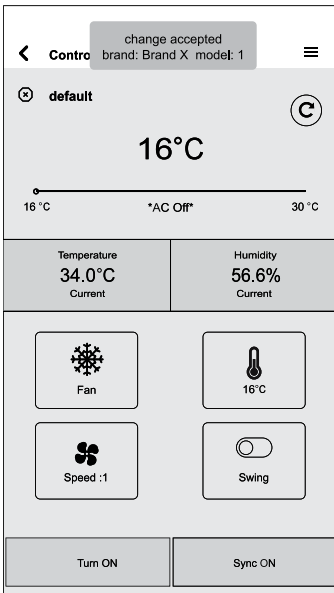

12. User and device are now successfully connected & ready to use.

AC brand Selection (Manual)

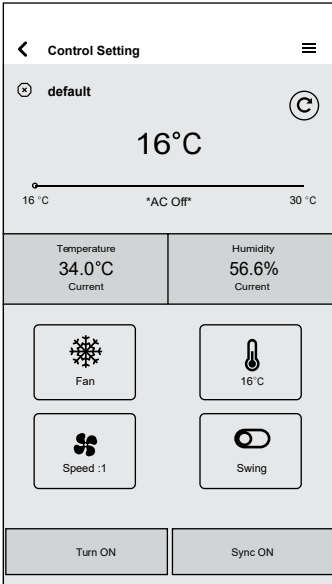

1. Click the 3 line at the top right corner.

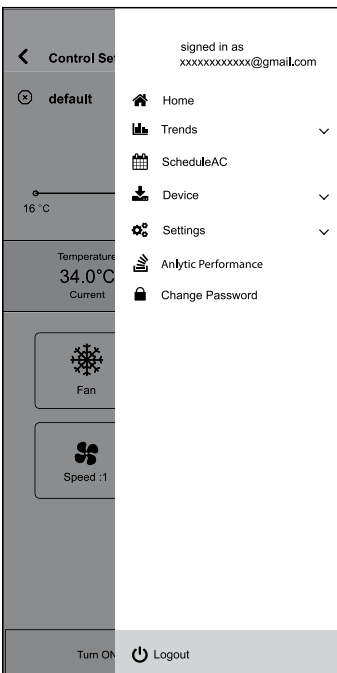

2. select "Settings".

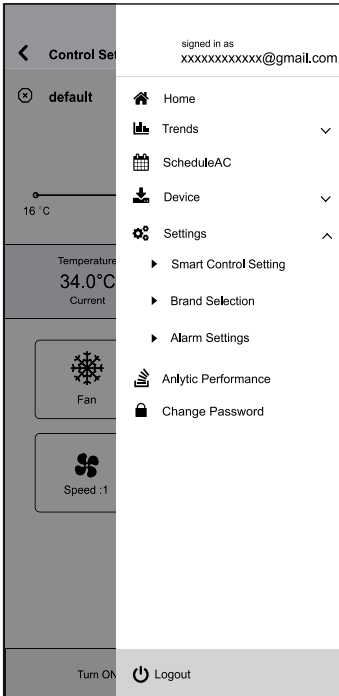

3. Choose Brand Selection

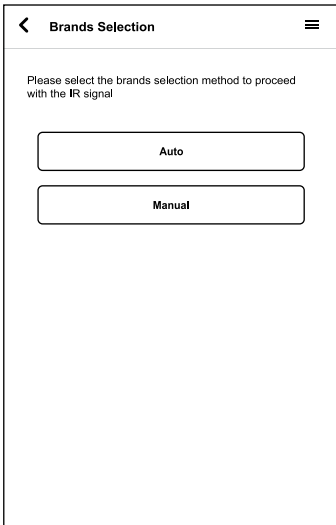

- 4) Select method to proceed with the IR signal pairing by Manual.
Follow the instruction before proceed.
*Make sure that AC is powered On before IR testing.
*Make sure T1 is aligned to AC IR receiver for proper testing.

< Choose AC Brand

Q Brand X x

Model Index:

Brand X

SAPORO

Colorful Star

QI DI

DONG AO

豐臣

Fujiaire

Sen Bao

5. Choose the brand of your AC, then select any model to do the testing .

< Choose Brand Model

Model Name : Brand X

Model 1

Model 2

Model 3

Model 4

Model 5

Model 6

Model 7

Model 8

Model 9

Model 10

Model 11

Model 12

Model 13

Model 14

TEST

6. Select any model to do the testing.

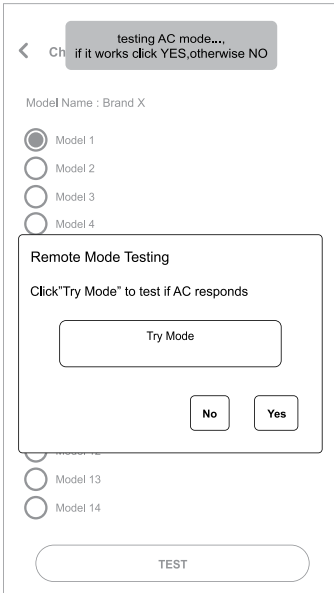

7. Click Try Mode for remote recognition. If AC respond, you must click Yes, If no response, click No.

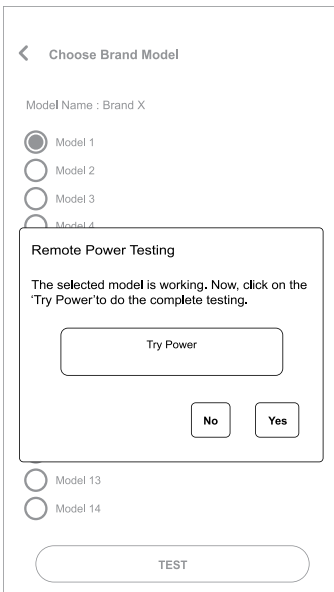

8. The selected model is working. Now, click on the "Try Power" to do the final testing. If AC respond, you must click Yes, If no response, click No.

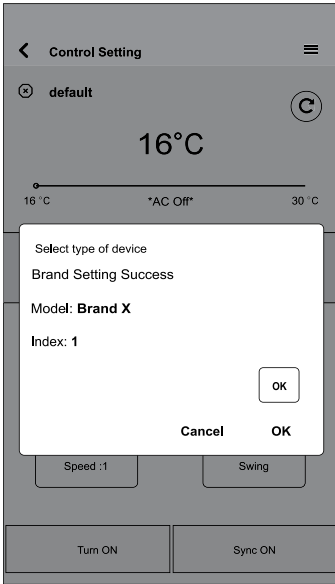

12. Upon completion, Click OK

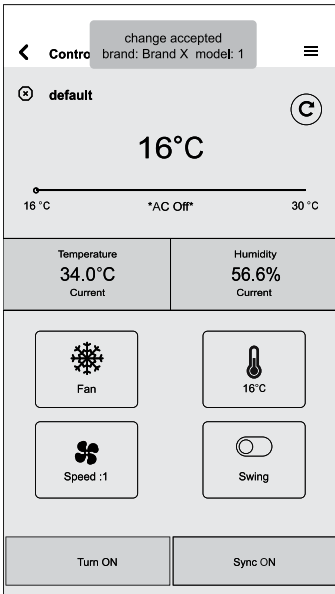

13. User and device are now successfully connected & ready to use.

Geolocation Functionality

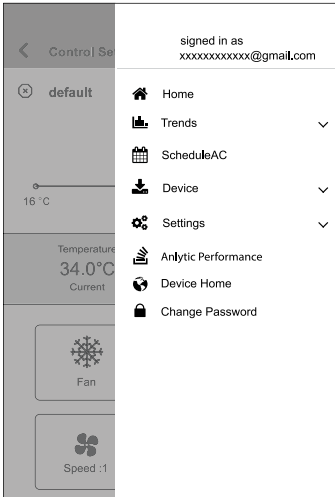

Setup :

1. On device page, select sidebar.
2. Select "Device Home".

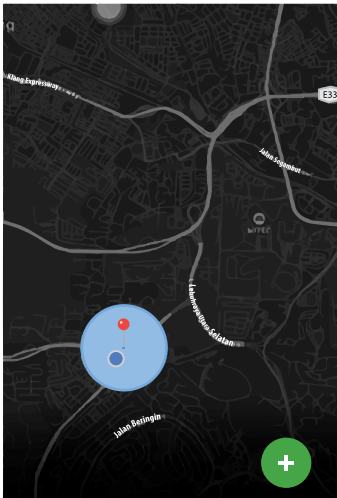

3. Press + button, select add home.

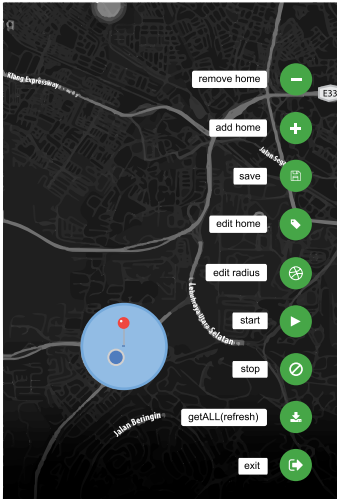

4. Pick the pin and drag to desired home location.

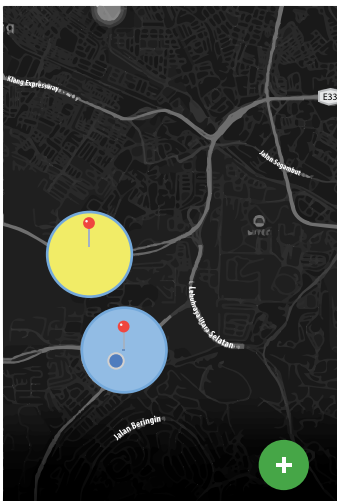

5. Click the + button and select edit home.

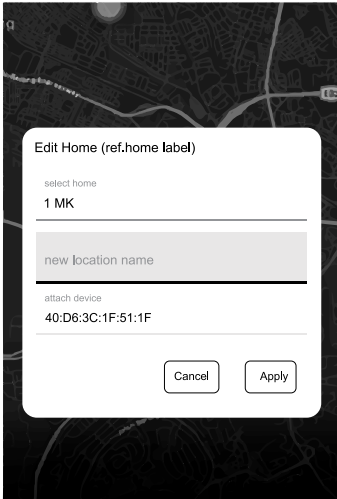

6. Select the new point that just dropped in
 - a. input the new location name.
 - b. Select device to be attached.



7. Upon setup done, press start to begin geolocation checking.

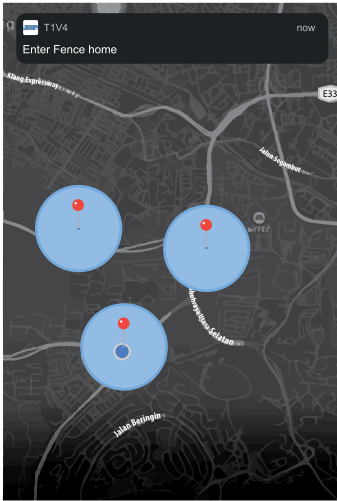

- 8. When entering location
 - a. There will be notifications in the screen.
 - b. T1 will turn on the AC

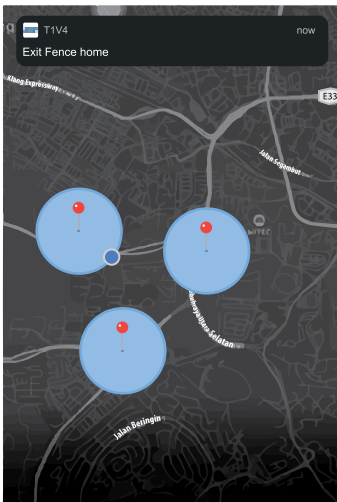

- 9. Upon Exit location
 - a. There will be a notification as the screen.
 - b. T1 will turn off the AC

Frequently asked question

Device not able to power up troubleshooting

- Ensure the power indication LED lights up. If the power indication LED does not light up, try using another power point, USB power brick, Micro USB cable
- The ADF logo should appear.
- If the power indication LED lights up but the T1 does not power up, power down device, keep pressing the factory default button and power up again.

System not working troubleshooting

Cloud setting not working

- Things to take note using apps or web pages to control T1
 - Ensure smartphone/laptop is connected to the internet
 - Ensure device is connected to the internet
 - Verify internet connectivity at the T1 HMI display

Shifting T1 to another AC Unit within same house/office

- Move T1 to that desired location (according to device placement guide)
- Ensure the T1 device is within the WIFI range (T1 shows online after power-on).
- Perform the AC Brand Selection Setup (Auto/Manual) only.
- T1 should be able to control the AC and can perform normally.

Shifting T1 to another AC Unit for different house/office

- Move T1 to that desired location (according to device placement guide)
- Perform factory reset on T1.
- Delete the T1 device in the mobile app
- Re-perform T1 setup steps from start again.
 - Add device
 - AC Brand Selection Setup
- T1 should be able to control the AC and can perform normally.

When AC Unit and Mobile App ON/OFF status not the same

- This could happen when accidentally used AC remote control to control AC unit.
- Perform Sync AC ON/OFF in the apps to make the status the same.

Setup process failed troubleshooting

AC setup process failed

- Ensure the T1 device is within 5m from the AC unit.
- Things to take note during AC Setup process
 - Ensure the T1 is pointed towards your Air-conditioner units
 - Ensure AC unit is powered up and turned on
 - Ensure the brand selected is correct
- If there is no AC model that supported, please report the issues through the AC brand report page.

Supported ac brands

- Refer to excel file for list of AC Brands supported by T1

Wifi setup process failed

- Things to take note during Wifi Setup process
- Ensure the T1 is placed near enough to the Wifi access point that you wished to set.
- Ensure Wifi router is powered up and turned on
- Ensure Wifi network is stable.
- Ensure Wifi network is 2.4Ghz as T1 does not support 5Ghz Wifi
- Ensure the Wifi hotspot channel is within 1-11

Technical support channel

- Go to any T1
- Click at the side menu and select support.
- Click "Need Help ?" button and it will link to a support web page
- The web pages provide an interface for the user to send a support request information with the following details:
 - Name
 - Email
 - Phone Number
 - Content

T1 Support

Get In Touch

Should you have any questions or inquiries about T1 product, please feel free to contact us via this form. Our support team will reach out to your enquiry as soon as possible.

- Upon sending this request, the email that contains all information mentioned above is sent to the technical support's email.